



**"Recreational Gear For
The Great Outdoors"**

IMPORTANT: Pack carefully in original package if possible. We are not responsible for damage incurred in returning items for repair. A letter stating your exact street address, daytime phone number, and the problem you are experiencing should be included. You must also enclose a copy of the original receipt a proof of date of purchase



**"Recreational Gear For
The Great Outdoors"**



Brooklyn, NY 11204
1 800 444 5671
Monday Through Thursday: 9AM to 5PM
Friday 9AM to 1PM Eastern.

www.pyleaudio.com

www.pyleaudio.com

Back Cover

Front Cover

1.0 Introduction

- Thank you for purchasing this Watch. Your Watch features electronic sensors, which measures and shows the outdoor conditions: weather forecast, temperature, pressure, altitude and compass directions.
- Your Watch provides the essential information you need when you go hiking, wild camping and other outdoor activities especially for a prolonged period.
- Your Watch also includes current time, daily alarm, chronograph, timer, pacer and dual time functions.
- Your Watch is carefully designed and produced for outdoor activities. In order to utilize the features, it is advisable to read the following instructions before using the Watch.:
 - Avoid exposing your Watch to extreme conditions for an unreasonable time.
 - Avoid rough usage or severe impact on your Watch.
 - Do not open the Watch's case unless by a certified service agency because your WeatherMaster contains delicate electronic sensors and components.
 - Clean your Watch with a soft cloth occasionally for a longer useful life.
 - Keep your Watch away from magnets or any appliances which contain magnetic objects such as mobile phones, speakers and motors.
 - Store your Watch in a dry place when it is not in use.

2.0 Buttons and Its Functions -Model A and Model B

Mode Button [M]

- To select among the Current Time, Daily Alarm, Chronograph, Timer, Pacer and Dual Time Modes.
- To select among the setting items in setting display.

Sensor Button [SR]

- To select among the Altimeter, Barometer and Compass Modes.

Start/Stop Button [S/S]

- To select between functional displays under the same mode.
- To activate the 'start' or 'stop' chronograph function in the chronograph mode.
- To toggle Yes/No.
- To increase the digits in setting display.

Lap/Reset Button [L/R]

- To activate the 'lap' or 'reset' chronograph function in the chronograph mode.
- To move the cursor to the left by one in the History recalling display.
- To decrease the digits in setting display.
- To toggle Yes/No.

EL Button [EL]

- To turn on the EL back light for about 3 seconds.

Note

Press any button to activate the watch under Power Saving Mode. (For more information, please refer to Chapter 14.0)

2.0 Buttons and Its Functions -Model A and Model B

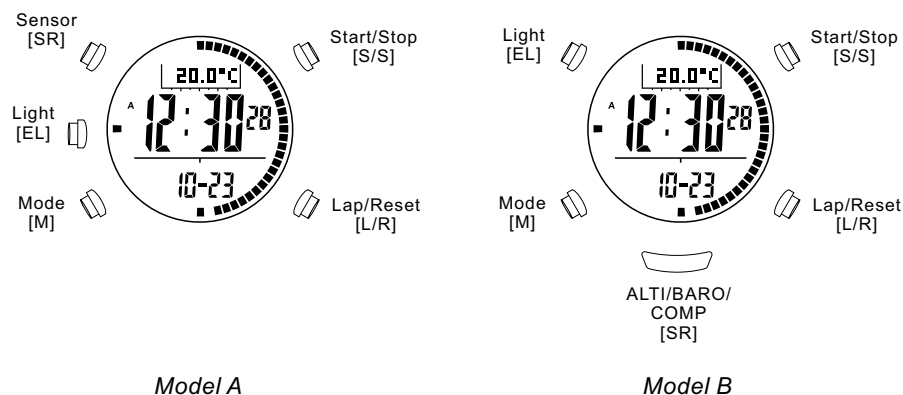

3.0 Major Function Modes - Timekeeping Mode and Sensor Mode

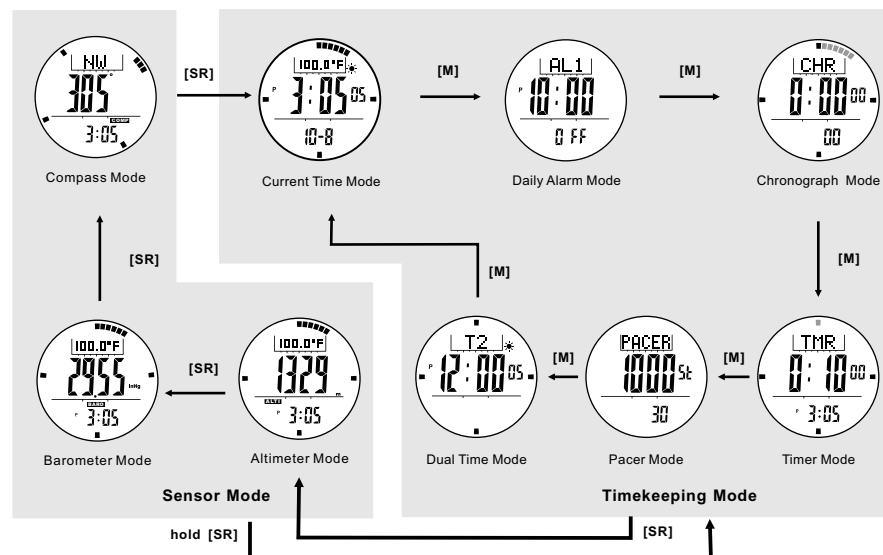

4.0 Current Time Mode - Functional Display

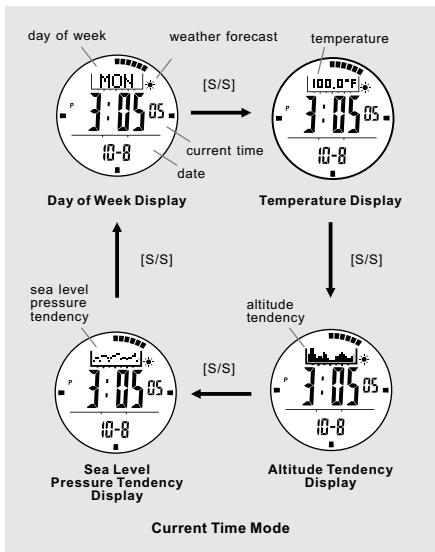

Functional Display

- The Current Time Mode includes 4 kinds of functional displays:
 - Day of Week
 - Temperature
 - Altitude Tendency
 - Sea Level Pressure Tendency
- To select among different functional displays, press the [S/S] button following the adjacent diagram.

Automatic Display Switching

- To activate the automatic switching feature, hold the [S/S] button.
- As long as the button is held, one of the 4 functional displays appears on the screen one by one.

4.2 Current Time Mode - Setting the Current Time

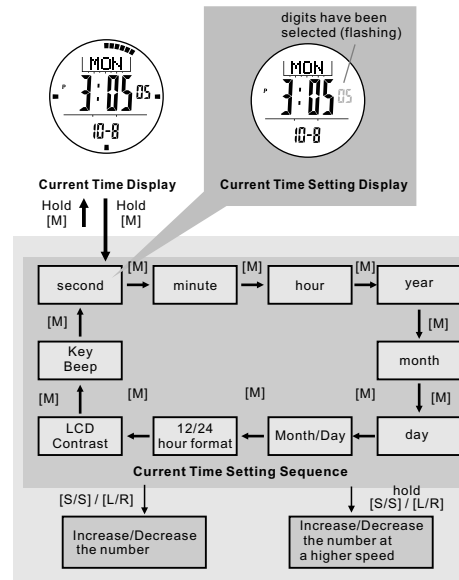

How to Set the Current Time

- To select the setting display, press and hold the [M] button for about 2 seconds in the Current Time Mode. In setting display, the flashing "SET" icon will appear.
- In the setting display, press the [M] button to change the selection following the adjacent Current Time Setting Sequence.
- When the second digits are flashing (selected), press the [S/S] or [L/R] button to reset the digits to "00".
- When the digits are flashing (selected), press the [S/S] or [L/R] button to increase / decrease the number. (Hold down the button to change the number at a higher speed).
- When month-day order setting is selected, press the [S/S] or [L/R] button to select either month-day or day-month format. When 12/24 hour format setting is selected, press the [S/S] button to select either 12 or 24 hour format.
- When the LCD contrast is selected, press the [S/S] or [L/R] button to increase / decrease the contrast level (1 to 10). When key beep setting is selected, press the [S/S] or [L/R] button to turn ON or OFF the beep.
- When the setting is completed, press and hold the [M] button to exit the setting display.

4.1 Current Time Mode - Weather Forecast Feature

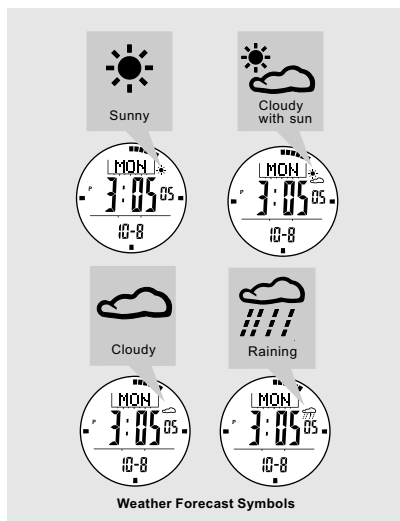

Weather Forecast Feature

- A special feature of the Watch is the coming weather predicting function. It works by analyzing the changes of the past air pressure.

How to Indicate the Coming Weather

- The Watch provides 4 different symbols to indicate the forecast weather, which are:
 - Sunny
 - Cloudy with Sun
 - Cloudy
 - Raining
- The symbols will only be shown in Current Time and Dual Time Modes.

IMPORTANT: Since the Watch predicts the coming weather by using the data of the changes in the air pressure, a higher accuracy may result when the user stays at the same altitude for at least 24 hours.

IMPORTANT: The Watch predicts the weather by adopting general weather prediction principles, it is NOT capable to reflect the dramatic changes of weather within a very short period of time.

5.0 Daily Alarm Mode - Daily Alarm 1, Daily Alarm 2 and Chime Display

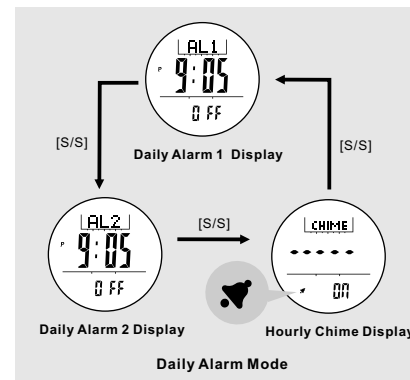

Daily Alarm 1 and Daily Alarm 2

- The Watch includes two daily alarms: Daily Alarm 1 and Daily Alarm 2. The Daily Alarm 1 and Daily Alarm 2 are working independently.
- Press the [S/S] button to switch among the Daily Alarm 1, Daily Alarm 2 and Chime Display following the adjacent diagram.

How to Turn ON/OFF the Daily Alarm

- To turn ON/OFF the Daily Alarm 1 (2), press the [L/R] button in Daily Alarm 1 (2) Display.
- When the Daily Alarm 1 (2) is ON, the alarm indicator '●●)' will appear.
- If the alarm indicator appears, the Watch will sound at the preset alarm time every day. When the alarm sounds, press any button to stop the beep.

How to Turn ON/OFF the Hourly Chime

- To turn ON/OFF the Hourly Chime, press the [L/R] button in the Chime Display.
- When the chime is ON, the chime indicator '▼' will appear. If the Chime indicator appears, the Watch will beep on the hour.

5.1 Daily Alarm Mode - Setting the Alarm

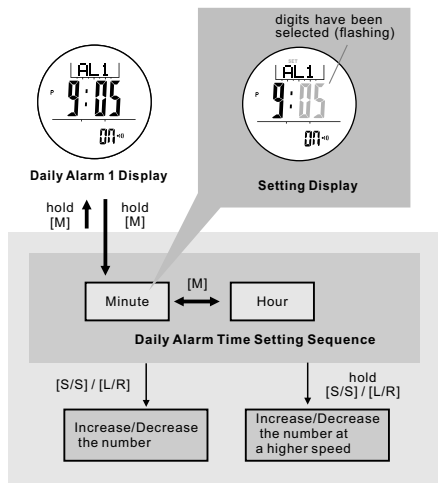

How to Set the Alarm 1 and Alarm 2

- To select the setting display, hold the [M] button for about 2 seconds in the Alarm 1 (2) Display, then the flashing "SET" icon will appear.
- In the setting display, press the [M] button to change the selection between minute and hour.
- When the digits are flashing (selected), press the [S/S] or [L/R] button to increase / decrease the number. (Hold down the button to change the number at a higher speed).
- When the setting is completed, press and hold the [M] button to exit the setting display.

6.1 Chronograph Mode - Recording and Recalling Lap Time

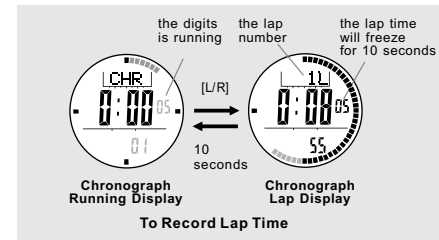

How to Record Lap Time

- The chronograph can measure elapsed time without stopping the counting - lap time.
- The Chronograph Mode allows recording lap time up to 100 laps.
- When the chronograph is counting, press the [L/R] button once to record a lap time (this key operation will not affect the counting).
- The lap number and lap time will appear on the display for 10 seconds, and it returns to counting display automatically.
- Repeat the steps mentioned above to get another lap time.

How to Recall Lap Times

- To recall lap time, hold down the [M] button in the Chronograph Display.
- When the Total Time Display appears, press the [S/S] or [L/R] button to check the next or previous lap time respectively.
- Hold down the [M] button to go back to the Chronograph Display.

How to Reset Lap times

- To record a new set of lap time, hold the [L/R] button for 2 seconds when it is stopped.

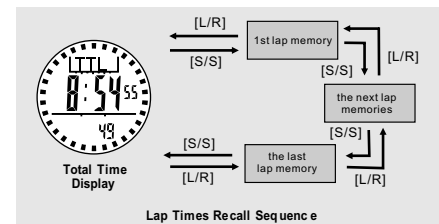

6.0 Chronograph Mode - Start/Stop the Chronograph

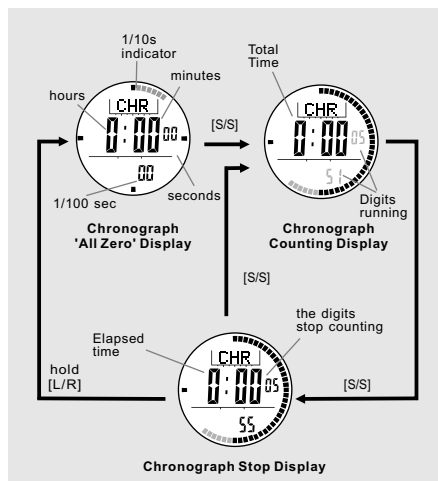

Chronograph Mode

- The Watch includes a function to measure elapsed time, accumulative elapsed time and lap times - Chronograph Mode.
- The display shows an 'All Zeros' display when the chronograph is selected the first time or it is reset.

How to Start/Stop the Chronograph

- When the chronograph is stopped (not counting), press the [S/S] button once to start the chronograph (counting); press the [S/S] button once again to stop the chronograph (not counting). Repeating these steps will get an accumulative elapsed time.

How to Reset the Chronograph

- To record a new set of elapsed time, hold the [L/R] button for 2 seconds to reset the chronograph to the 'All Zeros' display when the chronograph is stopped.
- In the 'All Zeros' display, the chronograph is ready for a new counting.

7.0 Timer Mode - Countdown Timer and the Quick-Set-Value

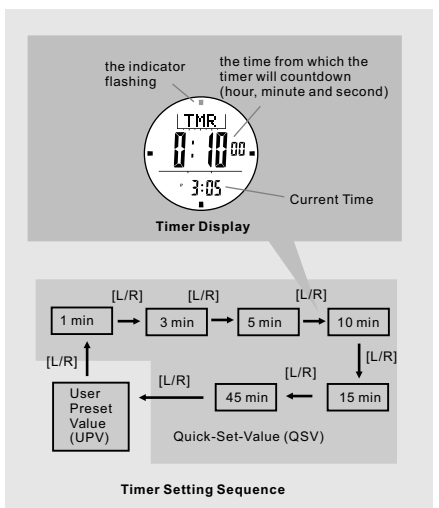

Countdown Timer

- The Watch includes a countdown timer feature: the Timer Mode.
- The Timer starts counting from the preset value to zero and stops at zero.

The Quick-Set-Value (QSV)

- The Quick-Set-Value is a set of values preset in the Watch for using the timer more easily.
- There are 6 Quick-Set-Values: 1, 3, 5, 10, 15 and 45 minutes, and these values CANNOT be changed by the user.

The User Preset Value (UPV)

- The User Preset Value is a value which can be set by the user.
- The setting limit is up to 99 hours 59 minutes 59 seconds.
- Once the User Preset Value is set, like 30 minutes, the value is stored into the Watch for the user to recall it in the future.
- To set the UPV, check the coming section "How To Set the User Preset Value" for more details.

Note: The adjacent diagram shows how to select the preset timer value. Press [L/R] button to select the preset timer value.

7.1 Timer Mode - Setting the User Preset Value

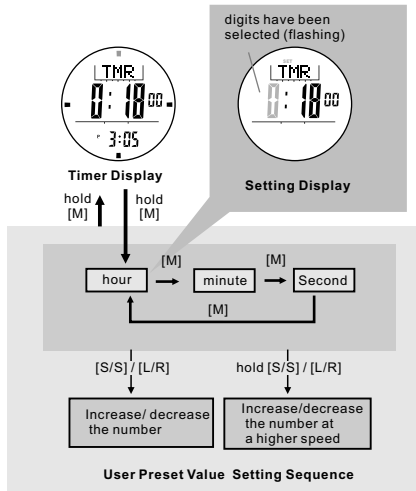

How to Set the User Preset Value

- To select the setting display, hold the [M] button for 2 seconds, and the flashing "SET" icon will appear.
- In the setting display, press the [M] button to change the selection among hour, minute and second.
- When the digits are flashing (selected), press the [S/S] or [L/R] button to increase / decrease the number. (Hold down the button to change the number at a higher speed).
- When the setting is completed, hold the [M] button to exit the setting display.

8.0 Pacer Mode - Using the Pacer

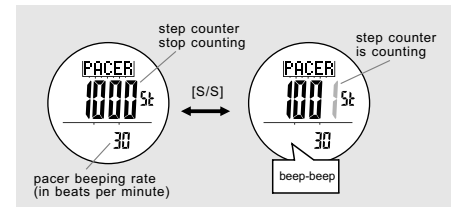

Pacer Mode

- When the pacer is activated, it will generate beeps at a pre-defined beeping rate.
- The beeping rate can be set from 30 to 180 beats per minute (BPM) in an increment of 5.

How to Use the Pacer

- When the beeping rate is set (for example 30 BPM), press the [S/S] button to start the beeping.
- When the watch is beeping, press the [S/S] button to stop the beeping.

Step Counter

- In supplementary to the Pacer Function, when the Pacer beeps once, the step counter will advance one.
- When the pacer is activated and the step counter starts counting, pressing the [S/S] button stops the pacer and step counter.
- The maximum counting limit of the step counter is 99999 steps.
- To reset the step counter to 0, hold the [L/R] button when the pacer is stopped.

NOTE: When the pacer has been running continuously for 8 hours, it will stop automatically.

7.2 Timer Mode - Using the Timer

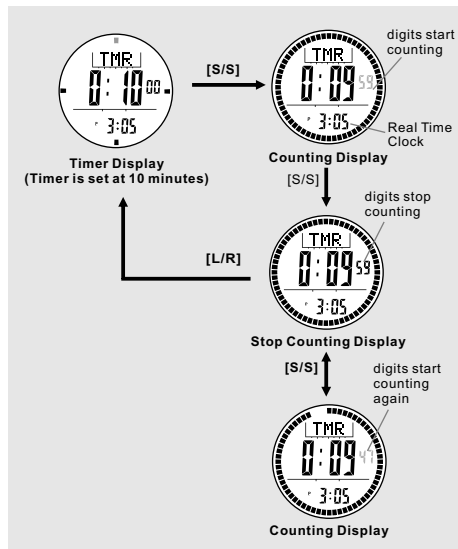

How to Use the Timer

- When the Timer is set, press the [S/S] button to start the timer. Press the [S/S] button once again to stop the timer.

Timer Alarm Sound

- In the last 10 minutes, the Watch will beep for every minute.
- In the last minute, the Watch will beep for every 10 seconds. In the last 5 seconds, the Watch will beep for every second.
- When it reaches 0, a beep sound will last for 30 seconds. Pressing any button can stop the beep sound.

How to Reload the Timer

- The last target time will be reloaded automatically at the end of the 30-second beep sound.
- Press the [L/R] button when the timer is stopped.
- To start a new counting by using a new target time, set the timer again either by QSV or UPV.

8.1 Pacer Mode - Setting the Pacer value

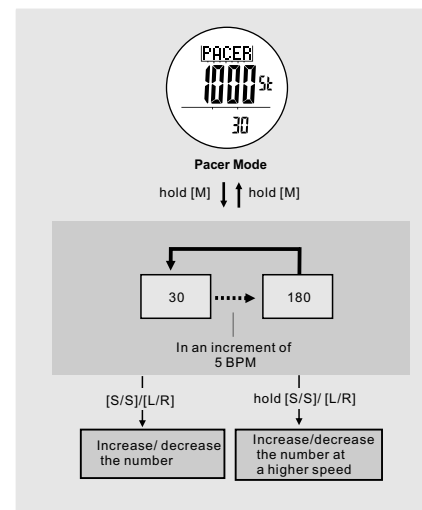

How to Set the Beeping Rate

- To select the setting display, hold the [M] button for 2 seconds in the Pacer Mode.
- When the beeping rate digits start flashing, press the [S/S] or [L/R] button to increase / decrease the number. (Hold down the button to change the number at a higher speed).
- When the setting is completed, press and hold the [M] button to exit the setting display.

8.2 Pacer Mode - Link with Chronograph

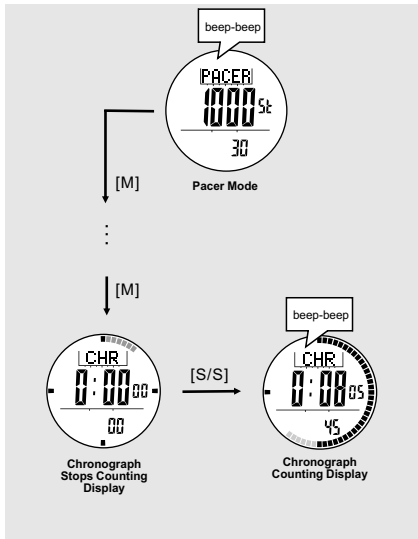

How to use the Pacer with the Chronograph

- When the Pacer Mode is ON: Press the [M] button to select the Chronograph Mode.
- Press the [S/S] button to start the counting and beeping at the same time.
- When the Chronograph is counting and the watch is beeping, pressing the [S/S] button stops the beeping sound and chronograph simultaneously.

10.0 Altimeter Mode - Temperature and History Display

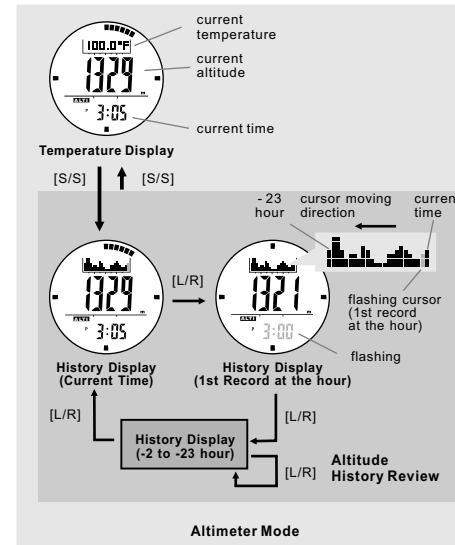

Functional Display

- The Watch includes two Altimeter functional displays: Temperature and History Displays.
- One of the two functional displays will appear in the top row of the display. The current (history) altitude and the current (history) time are shown in the middle row and bottom row of the display respectively.

History Display

- The Watch records the altitude readings automatically on the hour, i.e 1:00, 2:00, 3:00 and etc. These data will be used to plot an altitude record graph.
- In the History Display, the altitude graph is shown in the top row of the display.
- To review the altitude records of the last 23 hours, press the [L/R] button to move the cursor to the left cyclically, then the respective altitude record and its recording time (flashing) will appear on the display following the adjacent diagram.

Temperature Display

- In the Temperature Display, the top display shows the current temperature in degree Celsius (°C) or degree Fahrenheit (°F).

IMPORTANT: If you want to have an accurate reading of air temperature, you must take off the watch from the wrist that prevents body temperature effect on your watch.

9.0 Dual Time Mode - Dual Time and Setting the Dual Time

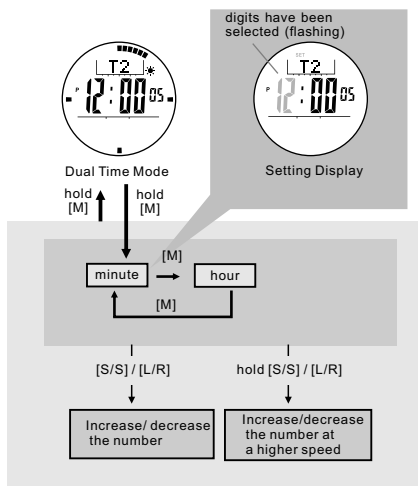

Dual Time Mode

- The Watch includes a function to show the time of a second time zone - Dual Time Mode.
- The second digit of the dual time synchronizes with the Current Time.

To Set the Dual Time

- To select the setting display, hold the [M] button for 2 seconds in the Dual Time Mode and the flashing "SET" icon will appear.
- In the setting display, press the [M] button to change the selection between minute and hour.
- When the digits are flashing (selected), press the [S/S] / [L/R] button to increase / decrease the number. (Hold down the button to change the number at a higher speed).
- When the setting is completed, press and hold the [M] button to exit the setting display.

10.1 Altimeter Mode -Unit Selection and Altimeter Adjustment

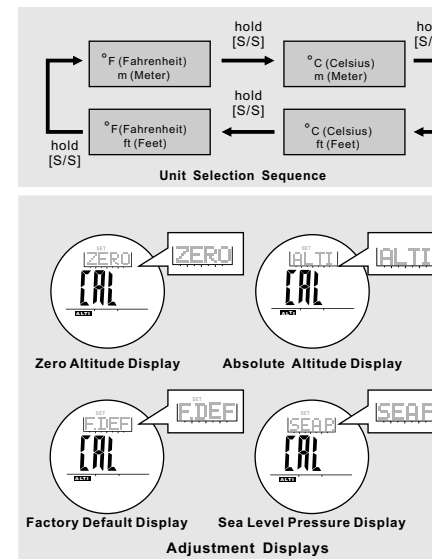

How to Switch between Units

- The Watch can display altitude in meter (m) or feet (ft) and temperature in degree Celsius (°C) or degree Fahrenheit (°F).
- To switch among different units, hold the [S/S] button to change the unit following the adjacent unit selection sequence.

Altimeter Adjustment

- There are 4 kinds of adjustment methods: the Zero Altitude, Absolute Altitude, Sea Level Pressure and Factory Default Adjustment.
- Zero Altitude: Adjust the altitude mandatorily to zero for relative altitude measurement. If the altimeter is adjusted by Zero Adjustment, the indicator "r" will appear on the display.
- Absolute Altitude: Set the altitude to a known value and it can be recalled for the next setting.
- Sea Level Pressure: Input a specific sea level pressure obtained from an official site.
- Factory Default: Restore the Watch to the default factory setting (1013.2mb) which is assumed to be the Sea Level Pressure.

NOTE: Altitude is calibrated independently of each mode. For example, if the absolute altitude is selected, the effect of previously set sea level pressure will be ignored.

NOTE: The Watch includes an automatic Sea Level Pressure compensation feature, this smart feature prevents fluctuation altitude readings from being recorded when staying at the same altitude.

10.2 Altimeter Mode - Zero Altitude Adjustment

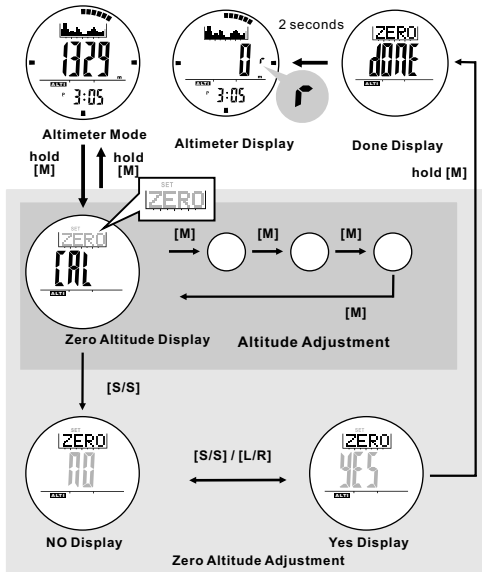

How to Measure the Relative Altitude

- The Watch can measure relative altitude, for example, it can measure the ascending or descending altitude between the starting point and the finish point of a trail.
- To measure the ascending or descending altitude of a trail by setting the current altitude to 'zero' mandatorily at a reference point like the starting point of a trail. An 'r' indicator will appear on the display.

Adjust the Altimeter by Using Zero Altitude Adjustment

- To select the Adjustment Display, hold the [M] button in Altimeter Mode. Then press the [M] button to select among the Zero Altitude, Absolute Altitude, Sea Level Pressure and Factory Default Adjustment.
- To adjust the Watch by using Zero Altitude Adjustment, press the [S/S] button in Zero Altitude Display, and the indicator "NO" will appear.
- When the indicator "NO" appears, press the [S/S] or [L/R] button to select between "YES" (reset the altitude to zero) or "NO" (abort the resetting).
- To exit the Adjustment Display, hold the [M] button for 2 seconds, and then the Watch will go back to the Altimeter Mode. If the "YES" Display is selected when exiting the Adjustment Display, the "DONE" Display will appear for 2 seconds prior to the normal operation.
- To restore the Watch to factory default, please refer to the coming section "Altimeter Mode - Factory Default Adjustment" for more details.

10.4 Altimeter Mode - Sea Level Pressure Adjustment

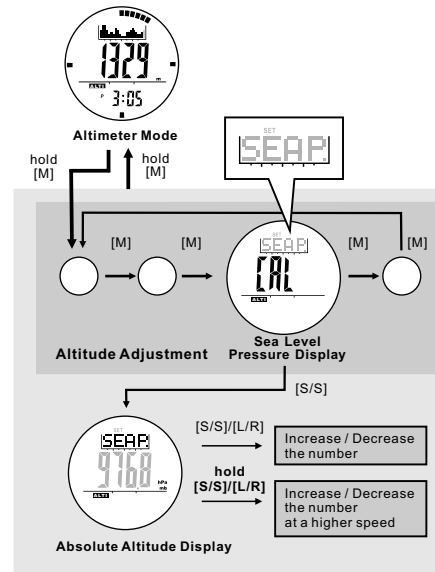

Why Need to adjust the Sea Level Pressure

- As altitude is calculated from the mean sea level, Air pressure changes contribute to the changes of the mean sea level.
- To achieve a more accurate reading, sea level pressure needs to be updated from place to place and from time to time.

How to Adjust the Altimeter Using Sea Level Pressure Adjustment

- You can adjust the current altitude reading by sea level pressure adjustment.
- To select the Adjustment Display, hold the [M] button in the Altimeter Mode. Then press the [M] button to select among the Zero Altitude, Absolute Altitude, Sea Level Pressure and Factory Default Adjustment.
- To adjust the altitude using Sea Level Pressure Adjustment, press the [S/S] button on the Sea Level Pressure Display, and the sea level pressure reading will appear.
- When sea level pressure reading appears, press the [S/S] or [L/R] button to increase or decrease the number to the target one. (Hold down the button changes the number at a higher speed).
- If the adjustment is completed, hold the [M] button to confirm and exit the adjustment display.

10.3 Altimeter Mode - Absolute Altitude Adjustment

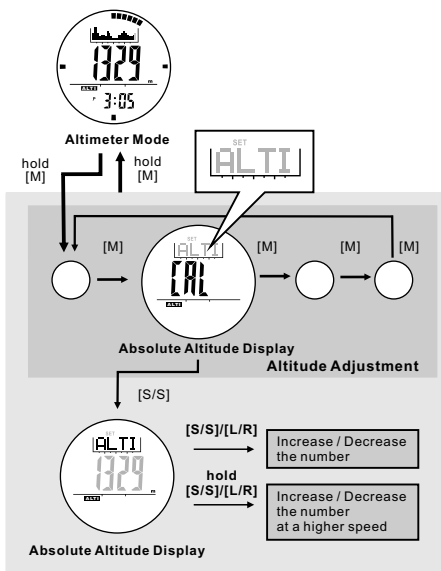

Why the Altitude Needs to be Adjusted

- As the absolute altitude is calculated from air pressure, the change of air pressure will affect the altitude reading.
- To achieve a more accurate reading, the WeatherMaster needs to be calibrated from time to time as pressure may change gradually even within hours.

Before Adjusting the Altitude

- Adjust the altimeter at a place where the altitude is known, such as sea level (0m) or beside an altitude sign pole (e.g., 89 m) because the altitude will be input into the Watch during the adjustment.

IMPORTANT: Inputting an incorrect altitude value during the adjustment results a mistaken altitude reading in future.

To Adjust the Altimeter by Using Absolute Altitude Adjustment

- You can adjust the current altitude reading to an absolute altitude value.
- To select the Adjustment Display, hold the [M] button in the Altimeter Mode. Then press the [M] button once again to select among the Zero Altitude, Absolute Altitude, Sea Level Pressure and Factory Default Adjustment.
- To adjust the altitude using Absolute Altitude Adjustment, press the [S/S] button on the Absolute Altitude Display, and the altitude reading will appear.
- When the altitude reading appears, press the [S/S] or [L/R] button to increase or decrease the number to the target one. (Hold down the button to change the number at a higher speed).
- If the setting is completed, hold the [M] button to confirm setting and exit the adjustment display.

10.5 Altimeter Mode - Factory Default Adjustment

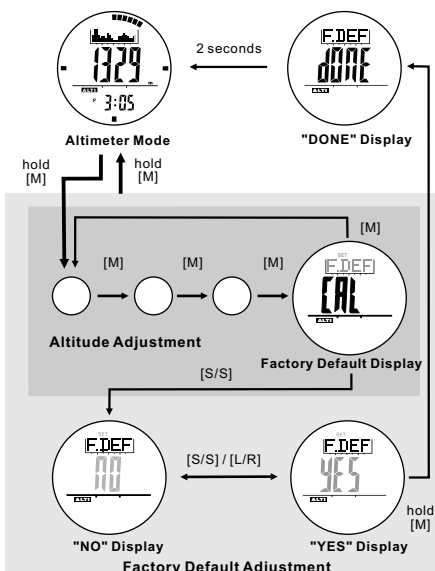

How to Adjust the Altimeter Using Factory Default Adjustment

- You can adjust the altitude reading calculation back to the factory default value.
- To select the adjustment display, hold the [M] button in the Altimeter Mode. Then press the [M] button to select among the Zero Altitude, Absolute Altitude, Sea Level Pressure and Factory Default Adjustment.
- To adjust the altitude using the factory default adjustment (restore to the factory default by setting the sea level pressure at 1013.2mb), press the [S/S] button on the Factory Default Display, and the indicator "NO" will appear.
- When the indicator "NO" appears, press the [S/S] or [L/R] button to select between "YES" (reset the pressure to factory default) or "NO" (abort the resetting).
- To exit the Adjustment Display, hold the [M] button for 2 seconds, and then the Watch will go back to the Altimeter Mode. If the "YES" Display is selected when exiting the Adjustment Display, the "DONE" Display will appear for 2 seconds prior to the normal operation.

11.0 Barometer Mode - Temperature and History Display

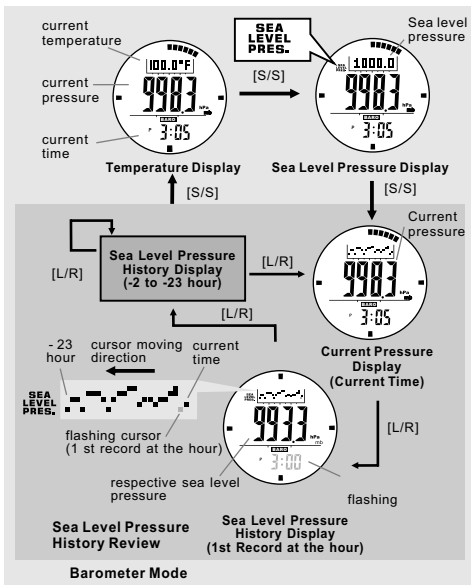

Functional Display

- The Watch includes three Barometer functional displays: Temperature, Sea Level Pressure and History Displays.
- One of the three functional displays will appear in the top row of the display. The current (history) pressure and the current (history) time are shown in the middle row and bottom row of the display respectively.

Temperature Display

- On the Temperature Display, the current temperature in degree Celsius ($^{\circ}\text{C}$) or degree Fahrenheit ($^{\circ}\text{F}$) is shown in the top row of the display.

IMPORTANT: If you want to have an accurate reading of air temperature, you must take off the watch from the wrist that prevents body temperature effect on your watch.

Sea Level Pressure Display

- On the Sea Level Pressure Display, the current sea level pressure is shown in the top row of the display.

Sea Level Pressure History Display

- The Watch records the sea level pressure readings automatically on the hour, i.e. 1:00, 2:00, 3:00 and etc. These records will be plotted into a pressure record graph.
- In Sea Level History Display, the pressure record graph is shown in the top row of the display.
- To review the pressure records of the last 23 hours, press the [L/R] button to move the cursor to the left cyclically, and the corresponding pressure record and its recording time (flashing) will appear on the display according to the adjacent diagram.

11.2 Barometer Mode - Absolute Pressure Adjustment

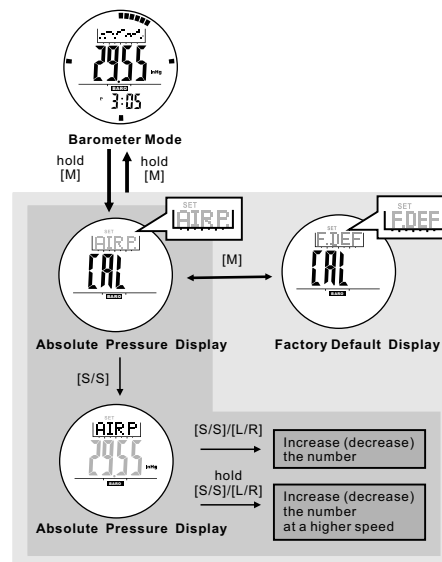

Before Calibrating the Barometer

- You have to know the absolute pressure of your current position because that pressure value will be input into the Watch during the adjustment.

IMPORTANT: Inputting an incorrect pressure during the calibration procedure results a mistaken pressure reading in future.

How to Adjust the Barometer Using Absolute Pressure Adjustment

- You can adjust the current pressure reading to an absolute pressure value.
- To select the Adjustment Display, hold the [M] button in the Barometer Mode. Then press the [M] button to select between the Absolute Pressure Adjustment and Factory Default Adjustment.
- To adjust the pressure using Absolute Pressure Adjustment, press the [S/S] button on the Absolute Pressure Display, and the pressure reading will appear.
- When the pressure reading appears, press the [S/S] or [L/R] button to increase / decrease the number. (Hold the button to change the number at a higher speed).
- If the setting is completed, hold the [M] button to confirm setting and exit the adjustment display.

11.1 Barometer Mode - Unit Selection and Barometer Adjustment

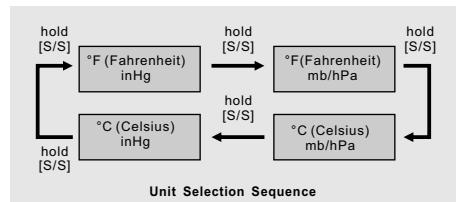

How to Switch between Units

- The Watch can display pressure in mb/hPa or inHg and temperature in degree Celsius ($^{\circ}\text{C}$) or degree Fahrenheit ($^{\circ}\text{F}$).
- To switch among different units, hold the [S/S] button to change the units following the adjacent unit selection sequence.

Why the Barometer Needs to be Adjusted

- The Watch has been calibrated for you in the factory. For normal use, you do not need to calibrate the Barometer.
- For serious users, the watch can be adjusted or calibrated.

Barometer Adjustment

- There are 2 kinds of Barometer adjustment methods: Absolute Pressure and Factory Default Adjustment.
- Absolute Pressure:** Input the known atmospheric pressure into the Watch directly.
- Factory Default:** Restore the Watch to the factory default setting.
- For in-depth information for each adjustment method, please read the coming sections for details.

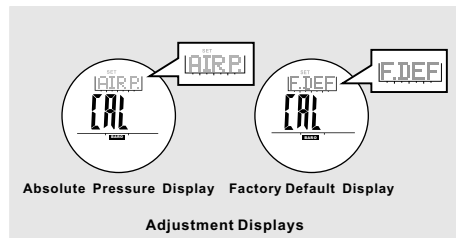

11.3 Barometer Mode - Factory Default Adjustment

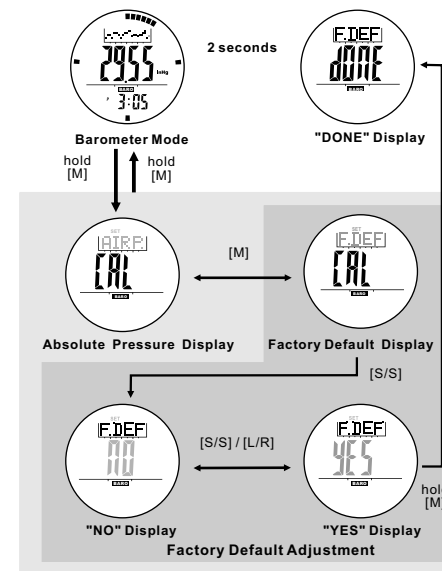

How to Adjust the Barometer Using Factory Default Adjustment

- You can adjust the pressure reading calculation back to the factory default value.
- To select the Adjustment Display, hold the [M] button in the Barometer Mode. Then press the [M] button to select between the Absolute Pressure Adjustment and Factory Default Adjustment.
- To adjust the pressure using the factory default adjustment, press the [S/S] button on the Factory Default Display, and the indicator "NO" will appear.
- When the indicator "NO" appears, press the [S/S] or [L/R] button to select between "YES" (reset the pressure to the factory default) or "NO" (abort the resetting).
- To exit Adjustment Display, hold the [M] button for 2 seconds, and then the Watch will go back to the Barometer Mode. If the "YES" Display is selected when exiting the Adjustment Display, the "DONE" Display will appear for 2 seconds prior to the normal operation.

12.0 Compass Mode - Precautions

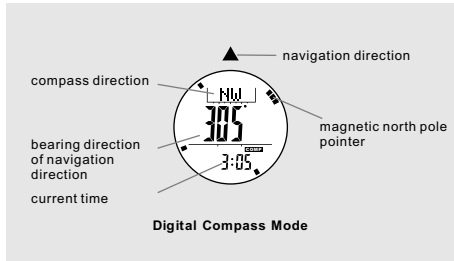

Precautions for using the Compass

- Keep your Watch away from magnets or any appliances which may contain magnetic objects such as mobile phones, speakers, motors and etc.
- The Watch, like most magnetic compass, points to the magnetic north which is slightly different from the true north. Check the 'What is Magnetic Declination' section for more details.
- Perform the compass calibration from time to time, because the calibration can ensure the precision of the compass.
- To achieve an accurate result, you should avoid measuring direction on the following conditions:
 - 1) The watch is placed close to the magnetic objects,
 - 2) The watch is placed close to the metal objects,
 - 3) The watch is placed close to the electrical appliances
 - 4) The watch is placed inside a moving object or a ferroconcrete building.

12.2 Compass Mode - Compass Mode

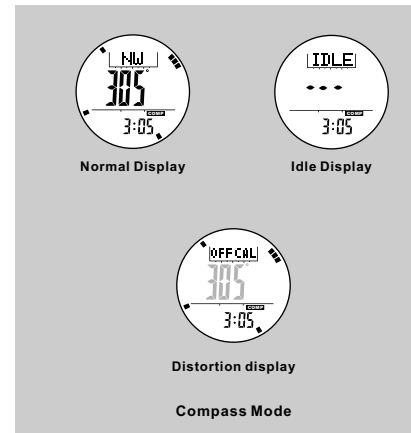

Compass Mode

- In the Compass Mode, the top row of the display shows the compass direction.
- The middle row of the display shows the bearing direction.
- The bottom row of the display shows the current time in hour and minute.
- The pointer encircled the display shows the direction of magnetic North analogically.

IDLE Mode

- If no key is pressed for about 1 minute, the watch will go to the IDLE Mode automatically. To activate the compass again, press any button.

Distortion

- If distortion is detected, the indicator "OFF CAL" and flashing bearing direction will appear.
- Please refer to the coming section "Calibrating the Compass" to restore the compass to normal operation when distortion is detected.

12.1 Compass Mode - Compass Directions and Bearing Directions

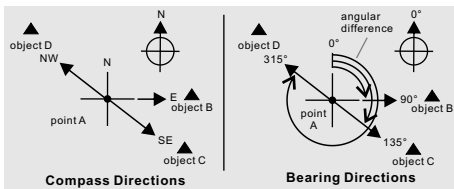

The Direction of an Object

- The direction of an object from a point can be specified in either compass directions or bearing directions.
- The Watch includes both compass directions and bearing directions.

The Compass Directions

- The compass directions are shown in the adjacent table.
- For example, in the figure on the left, the compass direction of object B from point A is due East. The compass direction of object C from point A is Southeast. The compass direction of object D from point A is Northwest.

The Bearing Directions

- The Bearing direction of an object is defined as the angular difference between North and the object. (Assume 0° for due North, and the measuring range is from 0° to 359°).
- For example, in the figure on the left, the bearing direction of object B from point A is 90°. The bearing direction of object C from point A is 135°. The bearing direction of object D from point A is 315°.

Marks	Compass Directions	Bearing Directions
N	North	349° - 11°
NNE	North Northeast	12° - 33°
NE	Northeast	34° - 56°
ENE	East Northeast	57° - 78°
E	East	79° - 101°
ESE	East Southeast	102° - 123°
SE	Southeast	124° - 146°
SSE	South Southeast	147° - 168°
S	South	169° - 191°
SSW	South Southwest	192° - 213°
SW	Southwest	214° - 236°
WSW	West Southwest	237° - 258°
W	West	259° - 281°
WNW	West Northwest	282° - 303°
NW	Northwest	304° - 326°
NNW	North Northwest	327° - 348°

12.3 Compass Mode - Backward Bearing Direction and Compass Lock

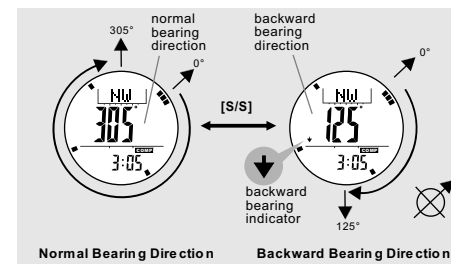

Backward Bearing Direction

- The Watch includes a backward bearing function.
- The backward bearing direction is the bearing direction in the opposite section from the normal bearing direction.
- When the 'Backward Bearing' indicator "▼" appears, the Watch is showing the backward bearing direction of the navigation direction.
- In the Compass Mode, press the [S/S] button to select between normal and backward bearing directions.

Compass Lock

- The Watch includes a compass lock function that locks useful direction reading.
- In the Compass Mode, press the [L/R] button to lock/unlock the direction reading.
- When the "Lock" indicator "🔒" appears, the compass direction, bearing direction and the magnetic north pole pointer are locked.
- Compass Lock will be released automatically when the Watch enters IDLE Mode.

12.4 Compass Mode - Applications of the Compass

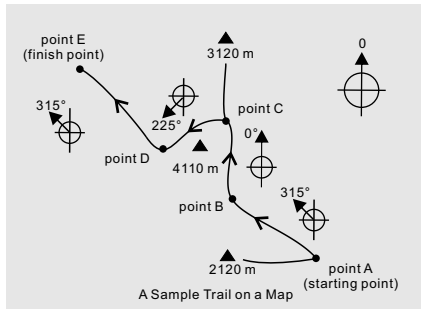
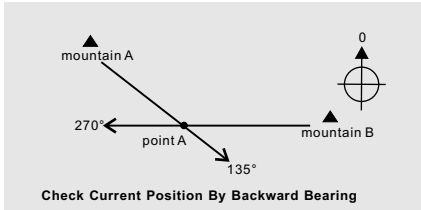

Check your position by Backward Bearing Directions

- Spot two distant identifiable landmarks like mountains, light-house, fort or building from your current position, for example the mountains A and B.
- Check out the backward bearing directions of mountains A and B from your current position, for example 135° from mountain A and 270° from mountain B.
- Use a ruler to draw a line 135° from the north at the mountain A to your current position on the map. Draw another line 270° from the north at the mountain B to your current position on the map.
- Your current position on the map will be the intersection (point A) of the lines 135° from the mountain A and 270° from the mountain B.
- Check the Trek Course Correctly**
- During a trekking, the Watch can keep your course in a correct way. For example, the correct trail starts from point A and finishes at point E as drawn on the adjacent map.
- Mark the points (identifiable landmarks) where the trail turns its direction or the trail branches its way, such as the points A, B, C, D and E on the adjacent map.
- Find out the bearing directions of point B from point A (315°), point C from point B (0°), point D from point C (225°), and then point E from point D (315°).
- During the trekking, make sure that the heading direction is 315° from point A to point B. Performing the similar checking in other sections of the trail helps you keep your course correctly.

IMPORTANT: If you are in doubt of the directions and positions of the trail, consult the park administration office before starting the trekking.

12.6 Compass Mode - Magnetic Declination Compensation

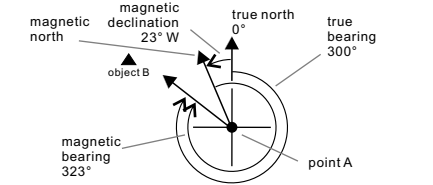

$$\text{True Bearing (TB)} = \text{Magnetic Bearing (MB)} - \text{Westerly Magnetic Declination (W)}$$

$$300^\circ (\text{TB}) = 323^\circ (\text{MB}) - 23^\circ (\text{W})$$

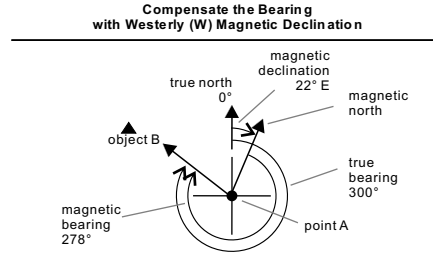

$$\text{True Bearing (TB)} = \text{Magnetic Bearing (MB)} + \text{Easterly Magnetic Declination (E)}$$

$$300^\circ (\text{TB}) = 278^\circ (\text{MB}) + 22^\circ (\text{E})$$

Magnetic Declination Compensation

- To compensate for an object's bearing, either subtract westerly (W) magnetic declination or add easterly (E) magnetic declination with the magnetic bearing.
- Example 1:** Westerly magnetic declination 23° and the compass needle points 323°.
 - TB = MB - W. When MB = 323°; W = 23°
 - TB = 323° - 23°
 - TB = 300°
 - The true bearing is 300°.
- Example 2:** Easterly magnetic declination 22° and the compass needle points 278°.
 - TB = MB + E. When MB = 278°; E = 22°
 - TB = 278° + 22°
 - TB = 300°
 - The true bearing is 300°.
- The Watch allows you to compensate the compass bearing at a place where the magnetic declination is either Westerly declination or Easterly declination.
- Check the coming section "Calibrating the Compass" for more details of the setting.

12.5 Compass Mode - Magnetic Declination

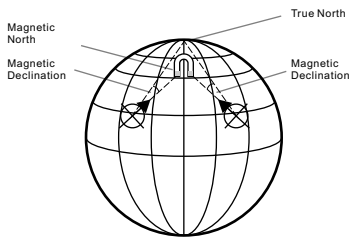

What is Magnetic Declination

- The Magnetic North Pole is slightly different from the True North Pole.
- The WeatherMaster, like most magnetic compass, points to the Magnetic North Pole. On the contrary, everything measured on a map is related to the True North Pole.
- The angular difference between Magnetic North Pole and True North Pole is called magnetic declination. Its magnitude (degrees and minutes) and direction (easterly and westerly) depend on where you are in the world.
- For a serious compass user who intends to perform an accurate navigation, the compass must be adjusted for magnetic declination.
- The Watch also includes a compensation setting for Magnetic Declination. Check the coming section "Calibrating the compass - Magnetic Declination Mode" for more details.

Magnetic Declination Information

- Most topographic maps include a small arrow which shows the magnetic north pole and magnetic declination information.
- For the benefit of the user, this manual includes the magnetic declinations for some major cities. Check the coming section "Magnetic Declination at Major Cities" for more details.
- For those cities, their names are not included on the list, please check the online magnetic declination information at:

- http://www.geolab.nrcan.gc.ca/geomag/e_cgrf.html
- <http://www.ngdc.noaa.gov/cgi-bin/seg/gmag/flidsth1.pl>

12.7 Compass Mode - Magnetic Declination at Major Cities

No.	Country/Place	Major City	Declination	No.	Country/Place	Major City	Declination
1	Afghanistan	Kabul	+3E	33	Netherlands	Amsterdam	+0E
2	Australia	Canberra	+12E	34	New Zealand	Wellington	+22E
3	Austria	Vienna	+3E	35	Norway	Oslo	+2E
4	Bahrain	Manama	+2E	36	Pakistan	Islamabad	+2E
5	Bangladesh	Dhaka	+0E	37	Philippines	Manila	-1W
6	Belgium	Brussels	+0E	38	Portugal	Lisbon	-3W
7	Brazil	Brasilia	-21W	39	Russia	Moscow	+10E
8	Canada	Ottawa	-14W	40	Singapore	Singapore	+0E
9	Chile	Santiago	+3E	41	South Africa	Cape Town	-24W
10	China	Beijing	-6W	42	Spain	Madrid	-2W
11	China	Hong Kong	-2W	43	Sweden	Stockholm	+5E
12	Costa Rica	San Jose	-1W	44	Switzerland	Bern	+1E
13	Cuba	Havana	-4W	45	Taiwan	Tai-pei	-4W
14	Czech Republic	Prague	+3E	46	Thailand	Bangkok	-1W
15	Denmark	Copenhagen	+3E	47	UAE	Abu Dhabi	+2E
16	Egypt	Cairo	+4E	48	United Kingdom	London	-2W
17	Finland	Helsinki	+8E	49	United States	Washington, DC	-11W
18	France	Paris	-1W	50	United States	Juneau	+22E
19	Germany	Berlin	+3E	51	United States	Phoenix	+11E
20	Greece	Athens	+4E	52	United States	Little Rock	+1E
21	Hungary	Budapest	+4E	53	United States	Sacramento	+14E
22	India	New Delhi	+1E	54	United States	Denver	+9E
23	Indonesia	Jakarta	+1E	55	United States	Atlanta	-4W
24	Israel	Jerusalem	+4E	56	United States	Honolulu	+10E
25	Italy	Rome	+2E	57	United States	Boston	-15W
26	Japan	Tokyo	-7W	58	United States	Saint Paul	+1E
27	Jordan	Amman	+4E	59	United States	Jackson	+0E
28	Kenya	Nairobi	+0E	60	United States	Santa Fe	+9E
29	Korea	Seoul	-8W	61	United States	Oklahoma City	+5E
30	Malaysia	Kuala Lumpur	+0E	62	United States	Salem	+16E
31	Mexico	Mexico City	+6E	63	United States	Harrisburg	-11W
32	Nepal	Kathmandu	+0E	64	United States	Salt Lake City	+12E

NOTE: Since magnetic declinations will be changed with time, it is recommended to check the updated data from following sites:
<http://www.magnetic-declination.com/> & <http://www.ngdc.noaa.gov/geomag/models/Declination.jsp>

12.8 Calibrating Mode - Calibration the Compass

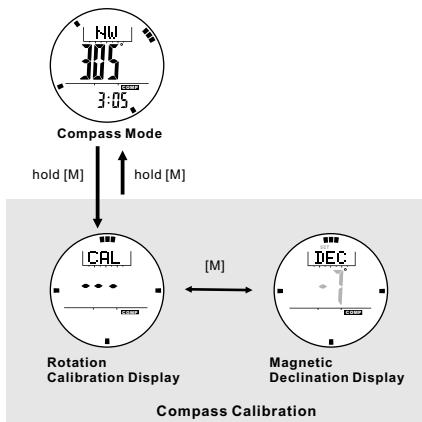

When to Calibrate the Compass

- The Watch has to employ a compass calibration in one of the following conditions:
 - The Watch is being used for the first time,
 - The battery is replaced,
 - The bearing direction digits are flashing and the "OFF CAL" indicator appears,
 - The compass is used in a location that is apart from the place in which the compass has been calibrated,
 - The user intends to maintain the precision of the digital compass.

How to Calibrate the Compass

- The compass calibration includes two different processes: Rotation Calibration Mode and Magnetic Declination Setting.
- It is advisable to conduct both calibrations from time to time to achieve a more accurate reading.
- IMPORTANT:** If the compass has not been calibrated, the direction made by the compass may be inaccurate.

12.10 Calibrating the compass - Magnetic Declination Mode

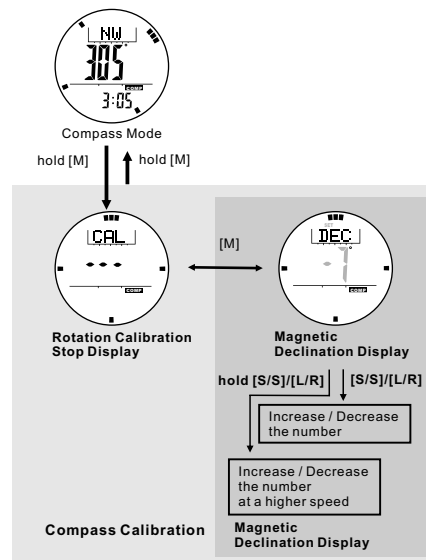

Magnetic Declination Mode

- Check the coming section "Magnetic Declination at Major Cities" to choose the magnetic declination of the city which is close to your current position. The angle will be input into the Watch during the calibration.
- To select Magnetic Declination Display, press the [M] button in Rotation Calibration Display.
- When the current magnetic declination appears, press the [S/S] or [L/R] button to increase/decrease the number. (Hold down the button to change the number at a higher speed).
- When the setting is completed, hold the [M] button to confirm the setting and exit the adjustment display.

12.9 Calibrating the compass - Compass Rotation Calibration Mode

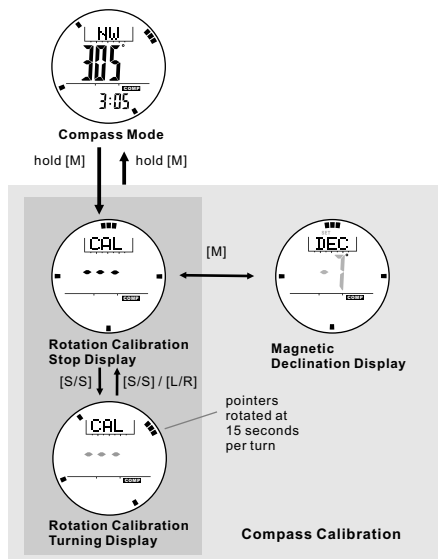

Rotation Calibration Display

- To select the Rotation Calibration Display, hold the [M] button in the Compass Mode.
- To start rotation calibration, press [S/S] button once. The pointers will start rotating, turning the watch (keep your watch horizontally) in the same direction of the rotating pointers for more than 2 turns.
- Press [S/S] or [L/R] button to stop the calibration when the 2-turn rotation calibration is completed.
- When the pointer stops rotating, hold the [M] button to go back to the Compass Mode or press the [M] button once to set the magnetic declination.

13.0 Low Battery Indication & Battery Replacement

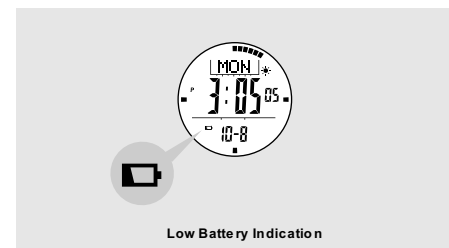

Low Battery Detection

- When the battery-low indicator appears on the display, it means that the capacity of the battery is low. It is recommended to replace the battery with a new CR2032 battery.
- However, if the appearance of battery-low indicator is caused by using the Watch under very cold condition, the indicator will disappear when normal temperature returns.

NOTE: It is recommended to complete the battery replacement by a certified service agency because this Watch contains delicate electronic sensors and components.

NOTE: The memory will be cleared when the battery is replaced. Follow the previous section "Calibrating the Compass" to calibrate the compass before using the Compass.

14.0 Power Saving Mode

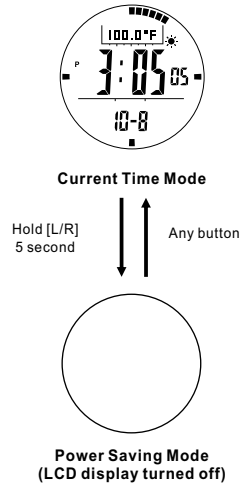

Power Saving Mode

- This Watch has a Power Saving Function which can turn off the LCD display so that the battery can last longer.
- In the Power Saving Mode, the watch function is still working normally. (i.e. The timekeeping function is still running in Power Saving Mode.)

How to enter/exit the Power Saving Mode

- To enter the Power Saving Mode, hold down the [L/R] button in Current Time Mode for about 5 seconds and the LCD display will be turned off.
- Press any key in Power Saving Mode to exit this mode and the LCD display will be resumed.

15.0 Specifications

Altimeter Mode

Resolution

- 1m (1ft)

Measuring range

- -706m to 9164m (-2316ft to 30065ft)

Sampling Interval

- First 5 minutes: 1 second
- After 5 minutes: 1 minute

History Recall

Barometer Mode

Resolution

- 1 hPa/mbar (0.01 inHg)

Measuring Range

- 300 hPa/mbar to 1100 hPa/mbar (8.85 inHg to 32.48 inHg)

Sampling Interval

- First 5 minutes: 1 second
- After 5 minutes: 1 minute

History Recall

Thermometer

Resolution

- 0.1 °C (0.1°F)

Measuring range

- -10.0 °C to 60.0 °C (14.0 °F to 140.0 °F)

Compass Mode

Resolution

- 1° display (digital)

- 1 to 60 pointers (graphical)

Measuring range

- 0° to 359° (digital)
- 1 to 60 pointers (graphical)

Others

- Digital bearing reading Lock
- Digital backward bearing

Backlight

- Electro-Luminescent (EL) backlight

Battery

- Single 3V lithium battery (CR2032)

15.0 Specifications

Current Time Mode

- Hour, minute, second, am, pm, month, date, and day of week/ sea level pressure history display/ altitude history/ temperature

Time System

- 12-hour or 24-hour format

Calendar System

- Auto-Calendar pre-programmed from the year 2004 to 2099

Weather Forecast

- 4 symbols to indicate the predicated weather

Daily Alarm Mode

- 2 daily alarms
- Hourly chime

Alarm Sound

- Sounds for 30 seconds at preset time of real time clock

Chronograph Mode

Resolution

- 1/100 second

Measuring Range

- 99 hours 59 minutes 59.99 seconds

Measuring Mode

- 100 laps memory
- Recall lap memory and total time

Timer Mode

Resolution

- 1 second resolution

Measuring range

- 99 hours 59 minutes 59 seconds

Operation Mode

- Countdown

Quick Set

- 6 quick preset Values (1, 3, 5, 10, 15 and 45 minutes)

Timer Sounds

- Sounds for 30 seconds when counting to zero

Pacer Mode

Measuring range

- 30 BPM to 180 BPM (an increment of 5)

Step counter

- Up to 99999 steps